

APPLICATION GUIDE BITUMODE

VERSION 1 (03/2021)



A SIKA COMPANY

CONTENTS

1 Scope

- 2.1 Transport
- 2.2 Loading/unloading
- 2.3 Storage
- 2.4 On site handling
- 2.5 Conservation
- 2.6 Climatic conditions for application
- 2.7 Waste disposal

2 Important considerations

3 Equipments

- 3.1 Personal protection equipment

4 Application guide

- 4.1 Substrate preparation
- 4.2 Priming
- 4.3 Alingment
- 4.4 Overlaps
- 4.5 Torching
- 4.6 Torching on vertical surfaces
- 4.7 Bonding the self adhesive membranes
- 4.8 Painting the membranes
- 4.9 Protected upstands

5 Detailings

- 5.1 Internal corners
- 5.2 External corners
- 5.3 Vertical drain
- 5.4 Horizontal drain
- 5.5 Protruding round element
- 5.6 Roof vent

6 Legal note

1 SCOPE

This publication is intended to provide the instructions to enable the correct execution for a successful waterproofing system composed by bituminous membranes.

2 IMPORTANT CONSIDERATIONS

2.1 TRANSPORT

The pallets are covered with a sheet of very thick heat-shrink polythene, but long journeys on uneven roads and sharp braking can cause the rolls to tip up. This problem can be avoided by running ropes through the rows of pallets, crosswise to the width of the bed of the lorry. The ropes must be properly tight and suitably protected to not leave marks on the rolls.

2.2 LOADING/UNLOADING

During handling, the material must be treated with care to avoid the rolls being crushed and prevent contact with sharp or pointed objects. In low temperatures, violent impacts must be avoided as they can break the membranes.

2.3 STORAGE

Product must be stored in original unopened and undamaged sealed packaging in dry conditions and temperatures between +5°C and +35°C. Do not stack pallets of the rolls on top of each other, or under pallets of any other materials during transport or storage. Always refer to packaging.

2.4 ON SITE HANDLING

Keep on site only the rolls strictly necessary for laying during the day. Set the rolls upright on a smooth and flat surface. Use a crane to lift the rolls onto the roof, keeping the pallet complete and intact and using suitable lifting gear. If the packs have to be opened and the rolls lifted loose, use suitable lifting gear with the crane and in any event set the rolls upright after lifting. Do not use ropes to tie and lift the rolls.

2.5 CONSERVATION

It is advisable to store the pallets in a dry place, sheltered from the sun. In the summertime, pallets with heat-shrink Modern exposed to the sun quickly reach a temperature of around 70°C. This causes progressive blackening from the top downwards of the talc coating or mineral granules on the rolls, until the point where the coils on the roll stick together or at any rate take on an unpleasant aesthetic appearance.

In the case of membranes reinforced with polyester non-woven fabric, the heat also causes the ends of the rolls to begin to shrink and thus wrecks the membrane.

It should also be borne in mind that exposure to heat, as is well-known, causes progressive and predictable loss of flexibility, but if what happens naturally in use happens instead to material still on the roll, it is possible that cracking problems or difficulty unrolling the material may occur.

In winter, the rolls should be stored for 24 hours at a temperature above +5°C before laying. Avoid leaving the rolls in the open overnight. Only the rolls that will be applied during the day should be brought onto the site.

A good rule is always to “rotate” the stock and not to keep rolls for more than 12 months.

2.6 CLIMATIC CONDITIONS FOR APPLICATION

Some types of product carry a symbol of a sun or a pine-tree printed on the strip at the bottom of the packaging, to identify the period of use for which the membrane was made and in which it is advisable to use the product.

It is advisable to apply membranes with the sun symbol during the summer months, and those with the pine-tree during the winter.

Failure to comply with the recommended application period does not reduce the efficiency of the finished membrane, but creates drawbacks and disadvantages when laying, such as excessive softness of the winter membrane when applied in the summer, and excessive stiffness and difficulty in unrolling the rolls of the summer product when used in the winter. The products should therefore be applied in favorable atmospheric conditions.

Rain, frost, snow and high humidity can interfere with the adhesion of the membrane to the substrate and at the overlaps. With temperatures below +5°C it is very likely that there will be ice on the surface to be covered, and the rolls will be more difficult to unroll. As a result, moisture trapped between the membrane and the substrate can give rise to the formation of bubbles. In these conditions, it is better not to apply the material. In summer, in hot countries, and especially when it is being laid over thermal insulation, it is advisable to apply the material in the coolest part of the day, avoiding the hours in the middle of the day when the sun is at its hottest.

2.7 WASTE DISPOSAL

The generation of waste should be avoided or minimized wherever possible. For further information about specific products, please refer to the respective current Safety Data Sheet. These materials and its container must be disposed of in a safe way. Disposal of this product and any by-products should at all times comply with the requirements of local environmental protection and waste disposal legislation and any relevant local authority requirements. Avoid dispersal of spilled material and run-off, including contact with soil, waterways, drains and sewers.

3 EQUIPMENTS



- Gas cylinder (propane)
- Burner
- Connections with pressure regulator
- T square, to cut uniformly the membranes
- “Delfino” knife or similar
- Rigid HDPE core
- Hot air machine or hand burner

3.1 PERSONAL PROTECTION EQUIPMENT

The handling and storage must follow the Safety Data Sheet instructions. Any specific local regulations and/or requirements must be fully complied with. Generally, we recommend to use glasses, gloves and protective clothes.

4 APPLICATION GUIDE

4.1 SUBSTRATE PREPARATION

The supporting structure must be of sufficient structural strength to apply all new and existing layers of the roof build-up.

The substrate must be uniform, firm, smooth and free of any sharp protrusion or burrs, clean, dry, and free of grease, bitumen, oil, dust and loosely adhering particles.

In the case of concrete and hollow-core substrates, it is advisable to allow a curing period of 8 days to 3 weeks, depending on the season, before laying.

If the substrate is an old membrane, make sure that it can be retained. First, however, remove unstable and perished parts, separate any protective sheet metalwork and flatten any bubbles etc.



4.2 PRIMING

Apply the appropriate primer at the correct consumption to the prepared dry surface and allow to dry before next application stage. Refer to the individual Product Data Sheets.

The primer has the very important function of prepare the receiving surface and increase the adhesion.

All surfaces/substrates requires primer, including old membranes.



4.3 ALINGMENT

Unroll the roll and align it before torching or bonding.

Each membrane must be laid parallel to each other and must be staggered by at least 1 m to avoid coinciding joints. The end-to-end overlaps must always be alternate, never arranged along a single line.

Always start on the lowest height of the slope and with the drains, the downpipes or other details.



4.4 OVERLAPS

The lateral overlap is the joint that runs in the direction of the length of the sheets and the end overlap is the joint along the shorter side of the sheet.

At the end overlap, a corner of the membrane must be cut off at an angle of 45°.

The overlaps must be welded with great care until a trickle of melted mixture about 1 cm wide can be seen coming out along the line of the overlap.

Do not fill the joints with trowel, spatula or other tool, because the reinforcement of the membrane can be affected, weakening it. In addition, the upper protective layer is removed and the reinforcement can be left exposed.

Always refer to the individual Product Data Sheet in order to verify the correct size of the overlapping.

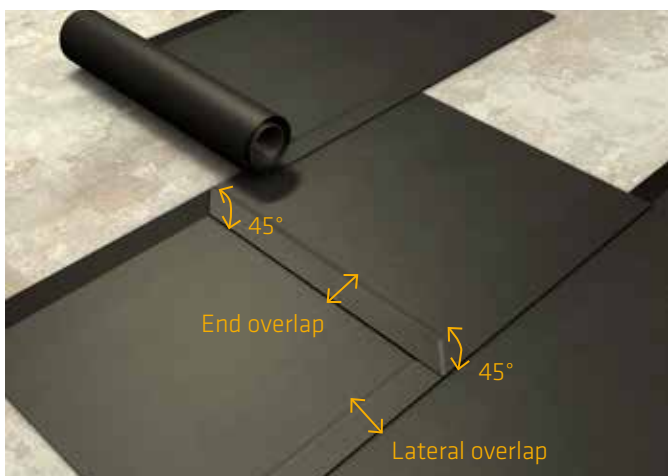
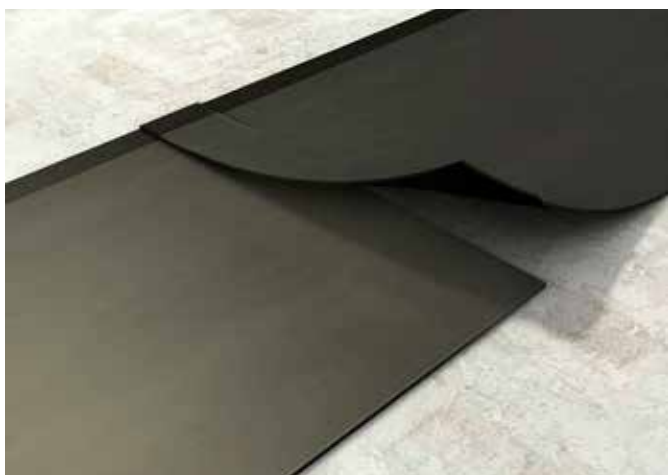

4.5 TORCHING

Use a gas burner to heat the substrate and the backing film on the underside of membrane. When the backing film starts to melt, the membrane is ready to stick.

Flame heating must bring retraction of the film and flattening of the embossing, but heating the membrane any further can damage the polyester reinforcement (which melts at 260°C) causing it to retract, undulate, curl or, in the most serious cases, to puncture. Insufficient heating, on the other hand, can cause insufficient adhesion to the base between the layers or on the overlaps.

The torching of the rolls must heat the membrane and the substrate at the same time, concentrating on the roll and the overlapping.

Whereas the lateral overlaps require adhesion zones free of grit, at the end overlaps the mineral-coated surface must be heated with a certain persistence so that melting consequently takes place over an area corresponding to the width of the overlap, with consequent melting of the bituminous mastic underneath.

Once the membrane compound, which will form the overlap, has been melted, this will enable the two edges to be welded perfectly.



The bonding operations will be facilitated if the sheets are wound around with a rigid plastic tube (HDPE, \varnothing 12 cm, length 97 cm), which will prevent the ovalisation of the roll during laying, particularly in summer.

At the same time, the pressure exerted on the roll will be uniformly discharged over the entire contact surface with the support, facilitating the release of the melted mixture along the overlap lines and ensuring that the membrane is perfectly welded.

If a second layer is specified, it must be laid to straddle the overlap of the previous layer and must be bonded in complete adhesion. The burner flame must also heat the membrane already laid.

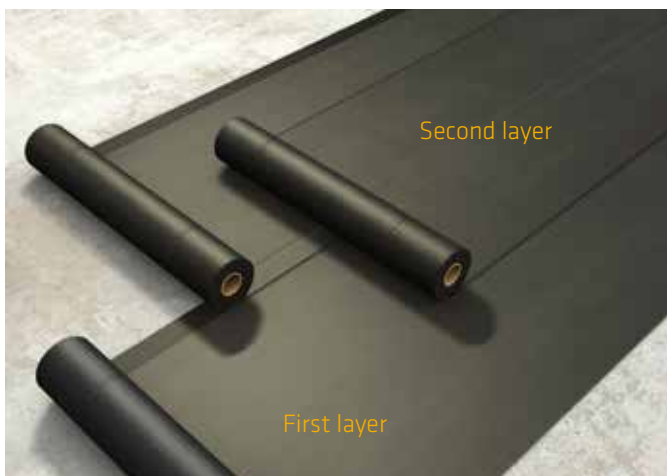

If the layers do not adhere well to each other, the water can pass through the innumerable “channels” existing.

The security of a multi-layered membrane is ensured exclusively by the complete adhesion between the layers, which make it up.

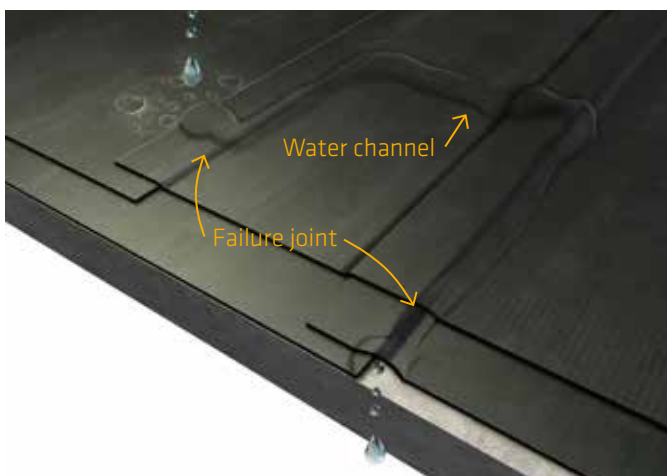

4.6 TORCHING ON VERTICAL SURFACES

The bituminous membranes have excellent resistance to sliding under heat and do not slip even when fixed vertically to concrete surfaces.

Use the flame to heat the membrane and the surface. The material's grip is produced by cooling, when the mixture in the melted layer returns to the solid state.

It may happen in the summer months that both, the membrane and the substrate, are so hot that they take a long time for sufficient cooling and full adhesion. In this case, the operator must carefully control the heating to prevent sliding of the membrane on the wall and fall.

It is also important to wait for the cooling and do not try to heat the membrane again.



If a recess has not been provided for a membrane in a vertical wall, a nailed and sealed profile must be fitted as an end finish for the membrane bonded to the wall.

Along the perimeter of the roof and on the flat, the membrane should be bonded completely to the substrate.



4.7 BONDING THE SELF ADHESIVE MEMBRANES

At one end of the sheet, peel away part of the silicone release liner from the underside and bond this part to the substrate. Then peel away the release liner sideways from the rest of the sheet to allow it to bond to the substrate. Then roll the entire surface area of the applied membrane with a suitable heavy roller ensuring any air bubbles are removed.



4.8 PAINTING THE MEMBRANES

The presence of uneven areas on the roof leads to the formation of puddles and can cause locally liftings.

Do not paint areas of the membrane that are perpetually immersed in water.

Select the appropriate painting considering the compatibility between technologies.

Some surfaces of membranes are not ideal for painting, such as talc or polyethylene foil. Always check the adhesion between the coating and the membrane.



4.9 PROTECTED UPSTANDS

If the top is prepared to house the membrane, it should be glued to its housing, which will then be covered with a metal net to provide a key to the mortar.

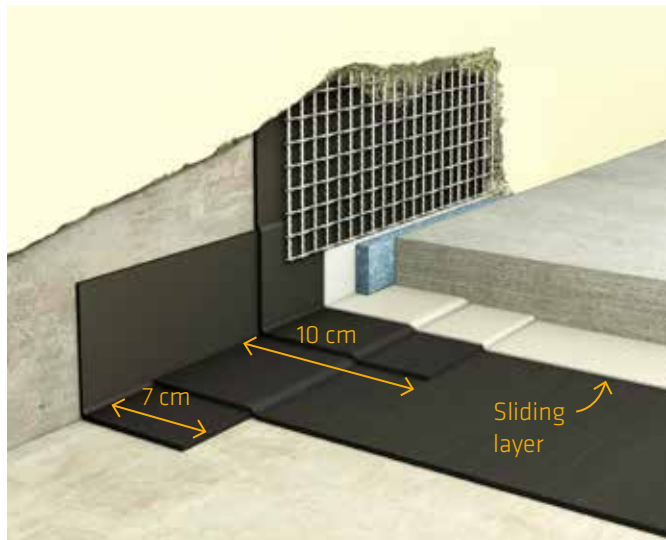

If the waterproofing membrane comes up to the top of perimeter walls, it must then be covered with a nailed flashing.

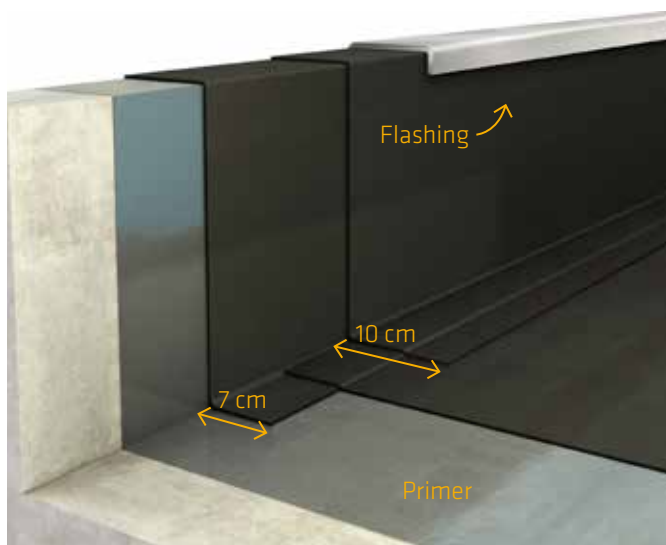

5 DETAILINGS

5.1 INTERNAL CORNERS

- Measure the size of the internal corner and cut a piece of the membrane, enough to cover all the foundation, height and more 10 cm of the horizontal surface. Then make two cuts according to the pictures below.



- Place the membrane on one side of the internal corner.

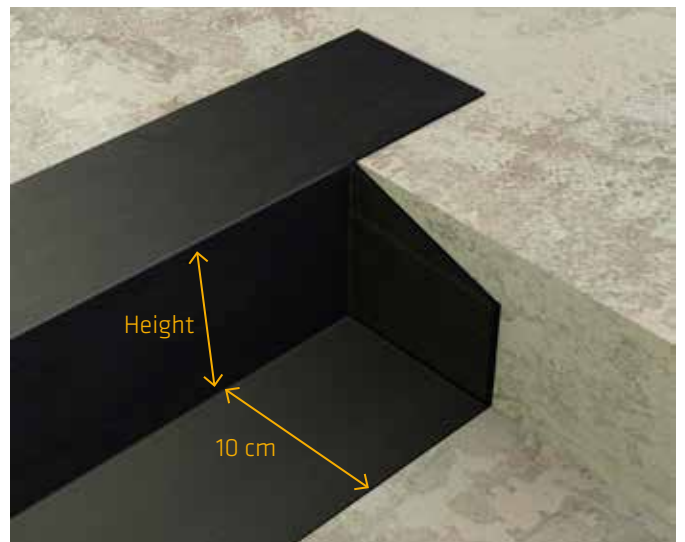
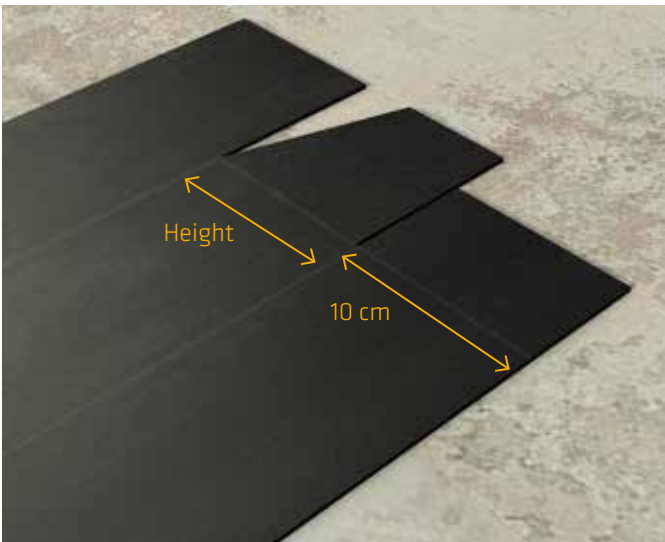

- Cut another piece of membrane, same size as the first, but without the cuts. Place it on the other side of the corner. Then proceed with the application of the first layer of the bituminous membrane.

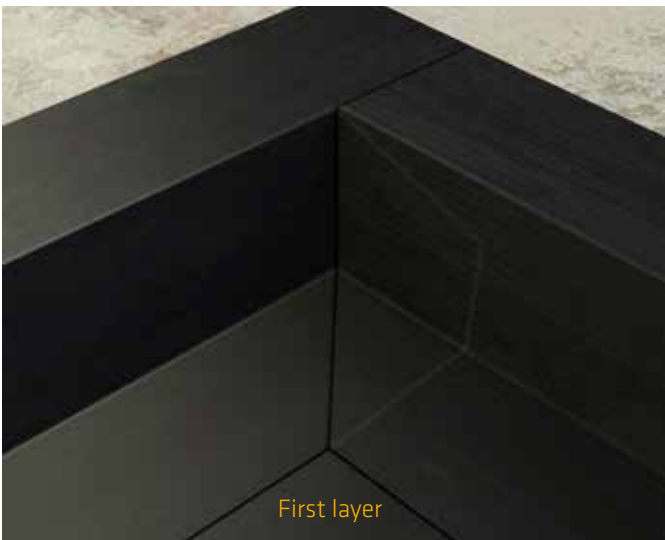
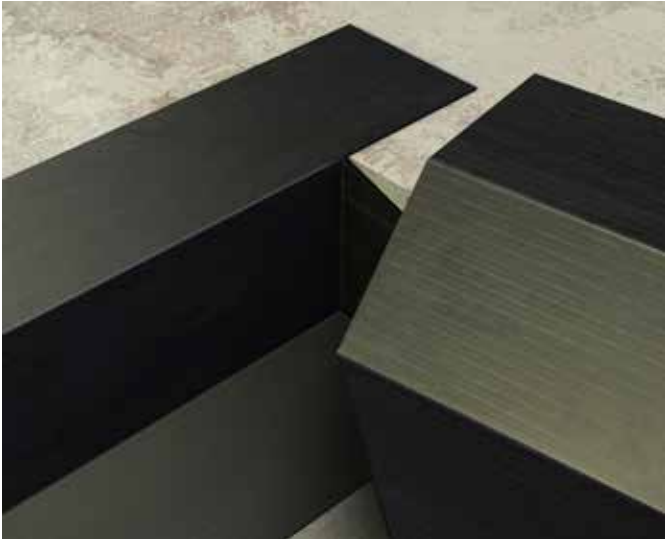

5.2 EXTERNAL CORNERS

- Measure the size of the external corner and cut two pieces of the membrane, enough to cover 10 cm of the top plus 10 cm of the surface. Then make two cuts, also with 10 cm, and apply on the corner.



- Cut two more pieces of the membrane and place onto the corner.



- Apply again another piece of membrane on top of the first layer, now on the opposite side of the corner. In this case, the overlapping should have an angle of 45°.

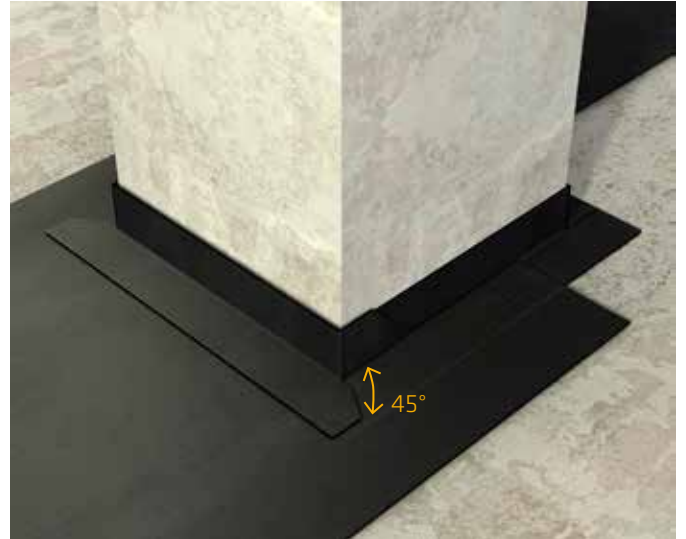

- Cut another piece of the membrane enough to cover the entire corner angle. This must be done for all the corner joints. Then proceed with the application of the first layer of the bituminous membrane.



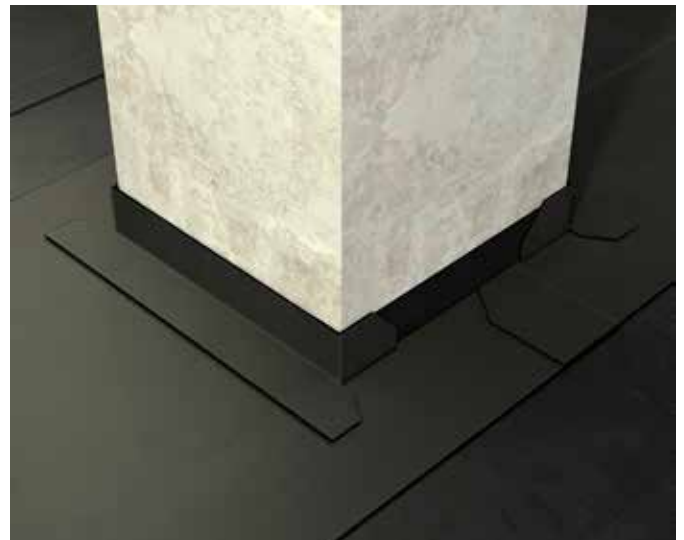
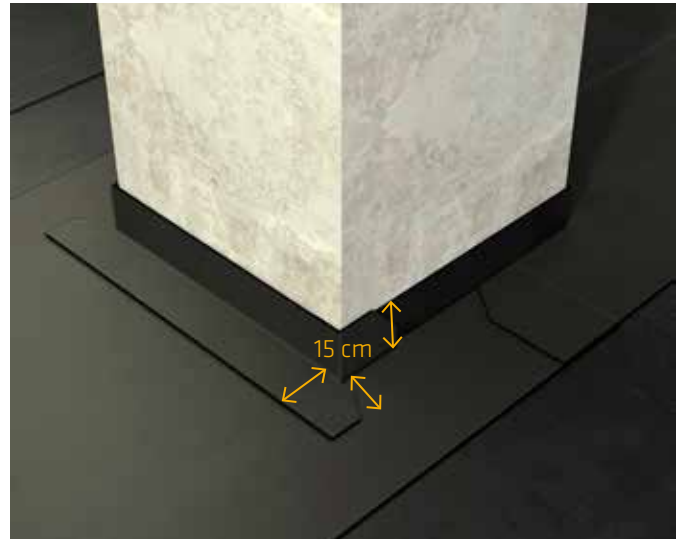

- In case of a multilayer system, proceed with the application of the second layer directly onto the first one and finish with the corner details, which must be 5 cm higher than the one below (vertical and horizontal).

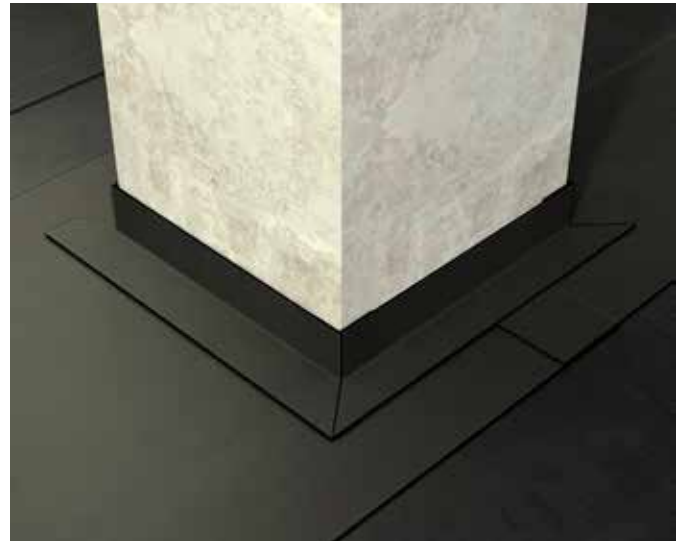
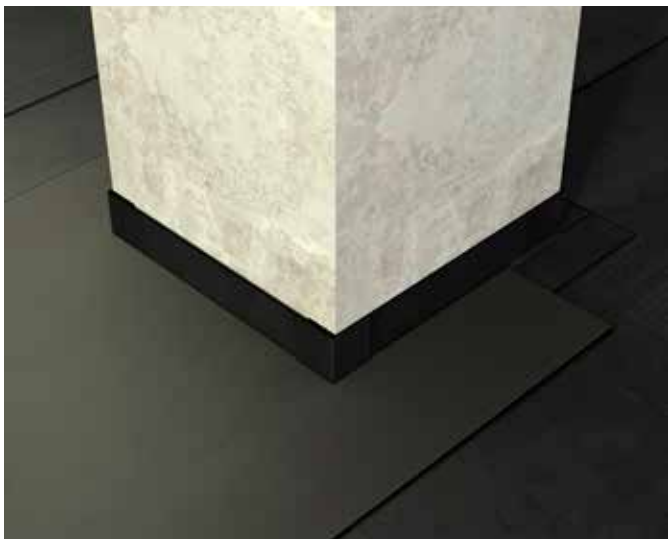

5.3 VERTICAL DRAIN

- Cut a piece of the membrane enough to cover 20 cm² of the surface of the drain. Then apply it onto the substrate.



- Place the drain and cover with another piece of membrane, half size of the first one. Then proceed with the application of the first layer of the bituminous membrane.

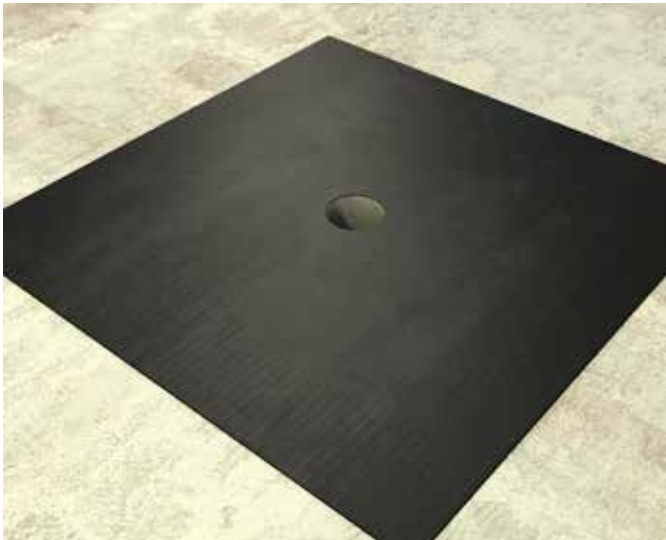

5.4 HORIZONTAL DRAIN

- Cut a piece of 1 m² of the membrane and apply it onto the substrate, covering the drain. Then insert the accessory.

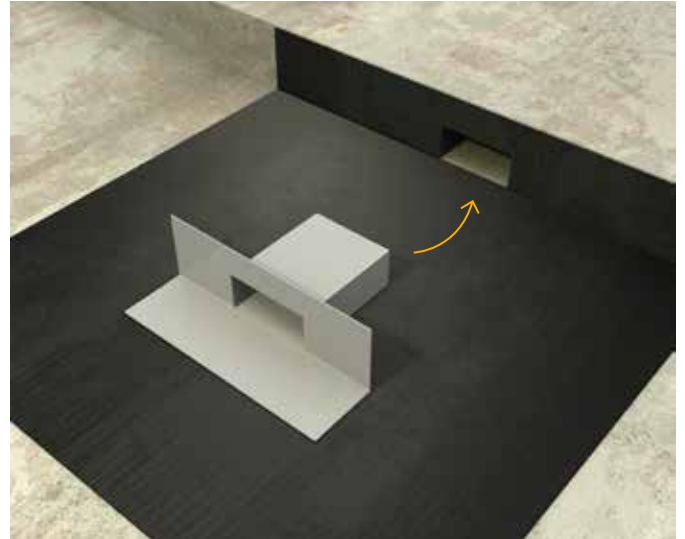

- In case of a multilayer system, proceed with the application of the second layer directly onto the first layer, but in the cross direction.



- Cut and apply another piece of the membrane, enough to cover 15 cm higher than the size of the drain and more 10 cm on the top. Cut more two pieces of the membrane, enough to cover 10 cm of the top and the surface. Then apply on both sides of the drain.



- In case of a multilayer system, proceed with the application of the second layer following the same steps of the first layer.



5.5 PROTRUDING ROUND ELEMENT

- Cut a piece of the membrane with 20 cm width and enough length to cover the entire round element. On one side, make cuts with around 30° according to the picture below. Apply onto the substrate, but leaving the joints free.



- Cut a square with 8 cm side and place it onto the center of the joint, bonding both sides.

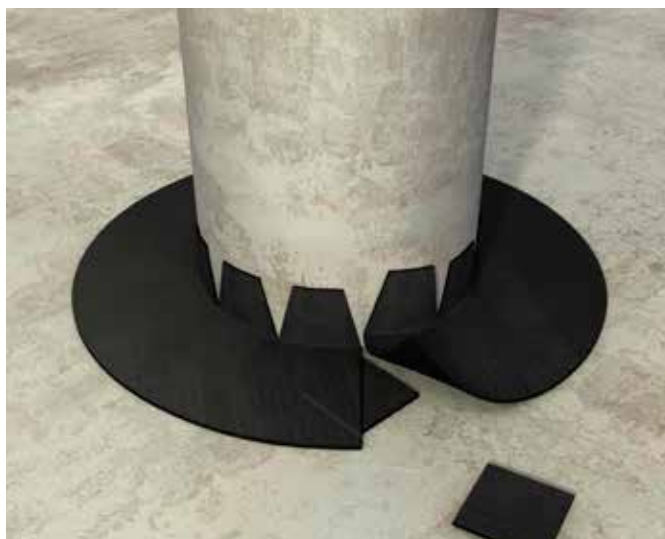

- In case of a multilayer system, proceed with the application of the second layer directly onto the first layer.

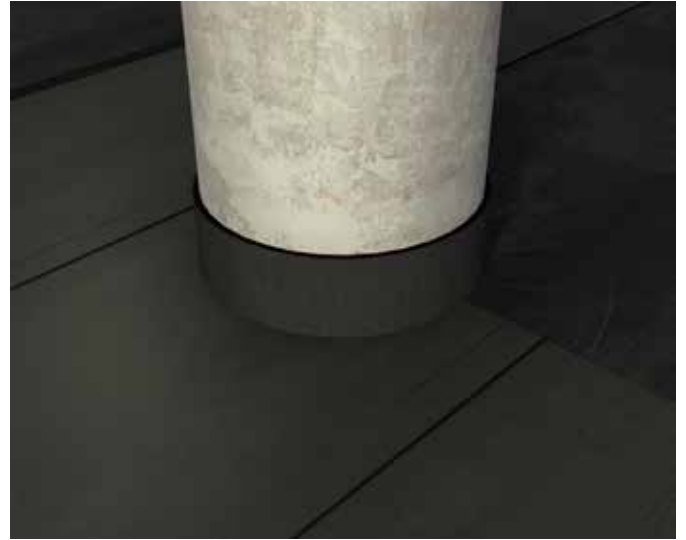

- Cut another piece of membrane, same size as the first, and bond on the opposite direction. Then proceed with the application of the first layer of the bituminous membrane.

5.6 ROOF VENT

- Apply the first layer of the bituminous membranes, making a cut where the roof vent will be installed.

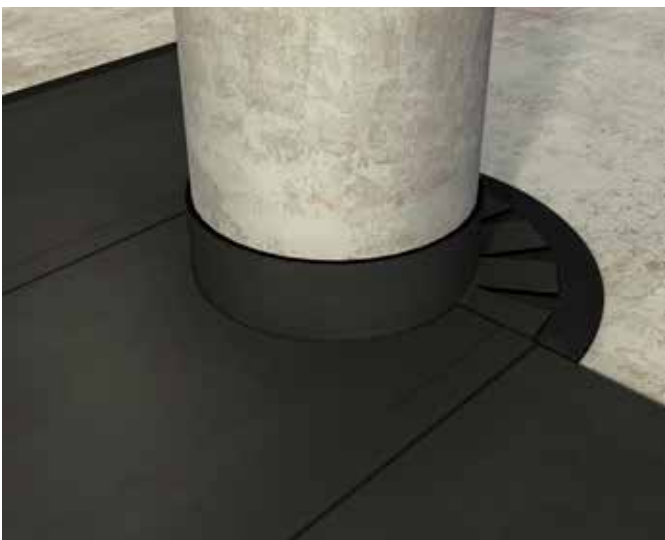

- Install the roof vent and bond the base with a piece of the membrane with diameter 10 cm larger.

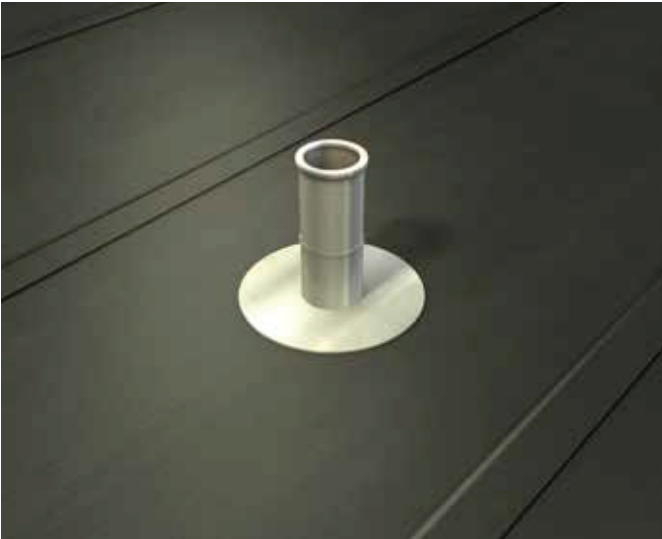

6 LEGAL NOTE

The information, and, in particular, the recommendations relating to the application and end-use of Modern products, are given in good faith based on Modern's current knowledge and experience of the products when properly stored, handled and applied under normal conditions in accordance with Modern's recommendations. In practice, the differences in materials, substrates and actual site conditions are such that no warranty in respect of merchantability or of fitness for a particular purpose, nor any liability arising out of any legal relationship whatsoever, can be inferred either from this information, or from any written recommendations, or from any other advice offered. The user of the product must test the products suitability for the intended application and purpose. Modern reserves the right to change the properties of its products. The proprietary rights of third parties must be observed. All orders are accepted subject to our current terms of sale and delivery. Users must always refer to the most recent issue of the local Product Data Sheet for the product concerned, copies of which will be supplied on request.

MODERN WATERPROOFING A SIKA COMPANY



MODERN WATERPROOFING
2, EL Soobki St., Dahabi Sq., Roxy, Cairo, Egypt
Tel: +(202) 24141003 (7 lines)



A SIKA COMPANY